**CONTROL DATA®
3446-A/B/C, 3644-A/B
CARD PUNCH CONTROLLERS
STANDARD OPTION 10194-1**

PREFACE

This publication contains reference information for CONTROL DATA® 3446-A/B/C, 3644-A/B Card Punch Controllers, and Standard Option 10194-1 which may be used in conjunction with standard Control Data 3000 series data channels. The reader should be familiar with characteristics of the 3000 series data channels.

CONTENTS

Functional Description	2	Codes	6
Card Format	2	Connect Code	7
Buffer Memory	2	Function Codes	8
Punching Cards	3	Status Codes	11
Suppress Disassembly Mode	3	Programming Considerations	13
Card Check-Read	4	Programming Procedure	13
Last Card Check	4	Timing	13
Sorting	4	Manual Operation	14
Parity	4	Switches and Indicators	14
Parity Error in Connect Code	5	Card Punch Switches and Indicators	14
Parity Error in Function Code	5	Controller Switches and Indicators	14
Parity Error During Write Operation	5	Operating Procedure	15
Interrupt	5		
Programming	6	Appendix A	

FIGURES

1 Typical System Configurations	1	2 Controller Switches and Indicators	14
---------------------------------	---	--------------------------------------	----

TABLES

1 System Specifications	2	2 Connect, Function, and Status Codes	7
-------------------------	---	---------------------------------------	---

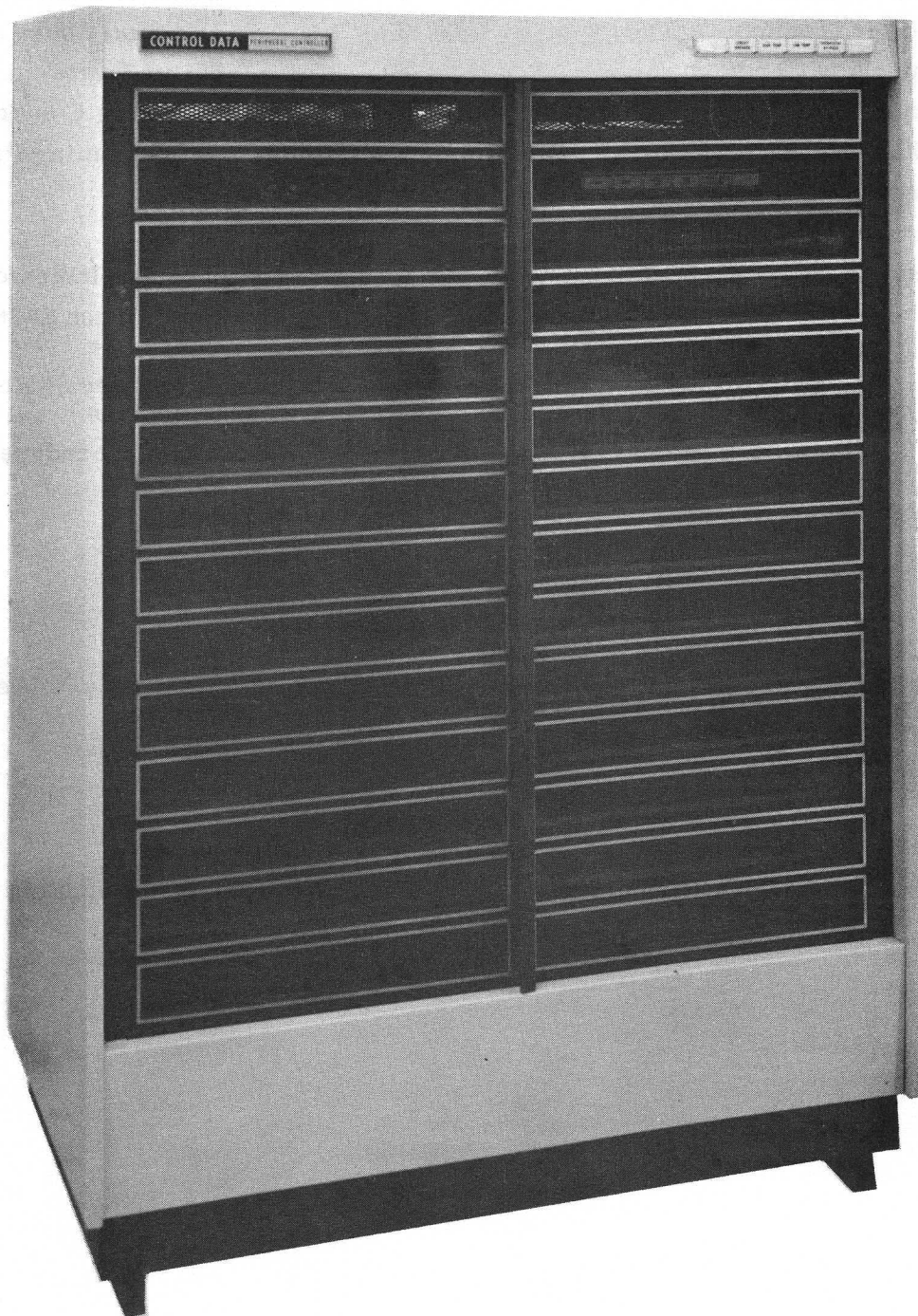

3644 CARD PUNCH CONTROLLER

3446-A/B/C, 3644-A/B CARD PUNCH CONTROLLERS STANDARD OPTION 10194-1

This manual describes a card punch system consisting of a CONTROL DATA[®] 3446-A/B/C, 3446-A/B/C with Standard Option 10194-1 which permits the 3446-A/B/C to convert internal BCD codes to ASCII Hollerith punch codes, or a 3644-A/B Card Punch Controller and a CONTROL DATA 415 or an IBM 523 Card Punch. These systems operate with any 3000 Series data channel. Figure 1 shows typical system configurations. Table 1 lists the specifications for systems using either punch. The controller occupies a cabinet separate from the basic card punch. The controllers are similar; however, there are two major differences:

1. The 3644-A/B is a two-channel device.
2. The 3446-A/B/C is a single-channel device.

Also with Standard Option 10194-1 installed, the 3446-A/B/C can accept Internal BCD codes and convert them to ASCII Hollerith punch codes.

The 3446-A/B/C is assigned an equipment number (0-7) to distinguish it from other equipment attached to the data channel while the 3644-A/B has two equipment number settings, one for each channel which may reserve the device. Reserve logic prevents both data channels from communicating simultaneously with the 3644-A/B Controller.

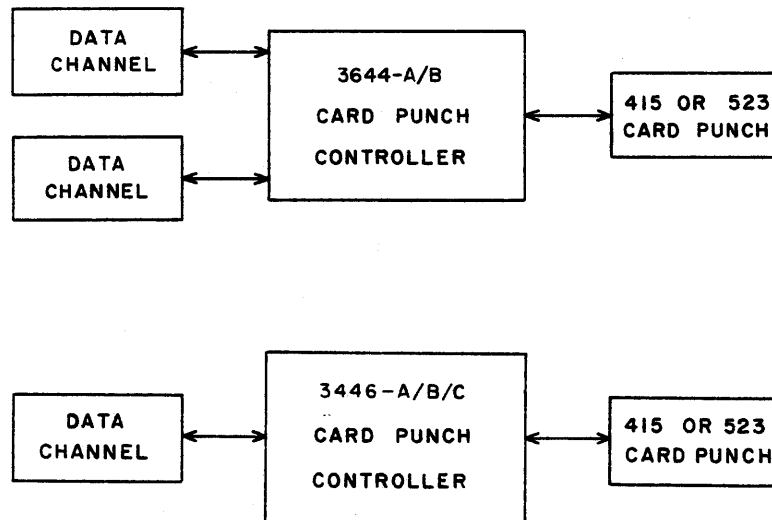

Figure 1. Typical System Configurations

TABLE 1. SYSTEM SPECIFICATIONS

	CONTROL DATA 415 Punch	IBM 523 Punch
Processing Speed	250 cards/minute	100 cards/minute
Input Hopper Capacity	1, 200 cards	725 cards
Stacker Capacity	1, 500 cards	725 cards
Type of Cards	80-column only	80-column only
Data Transfer Rate: Buffer memory in controller permits high-speed transfer from data channel, 2, 560 microseconds per 80-column card.		

FUNCTIONAL DESCRIPTION

CARD FORMAT

The card punch system can handle 80-column cards only. Cards can be punched in either standard Hollerith or binary format when using either a 3446-A/B/C or 3644-A/B Controller while the 3446-A/B/C with Standard Option 10194-1 allows the card punch to punch cards in ASCII Hollerith, standard Hollerith or binary formats. Appendix A, Punch Card Format and Codes, describes the card.

BUFFER MEMORY

The controller contains a buffer memory that holds 80 12-bit words, one card image. This memory permits the data channel to transfer at a very rapid rate the bytes necessary to punch one card. The information is then read out at the relatively slow rate required by the punch. When the actual punching takes place, the data channel need not be connected to the punch system and may be used to serve some other device.

The memory can be fully loaded in 2.2 milliseconds for a Hollerith card (40 bytes) or in 2.5 milliseconds for a binary card (80 bytes). The time required to punch a card is:

1. 240 milliseconds for the 415 Punch.
2. 600 milliseconds for the 523 Punch.

PUNCHING CARDS

The card punch system is controlled by a data channel. It punches cards only as long as the data channel transmits data bytes in response to a Write (Output) instruction.

The controller forms a card image in a buffer memory from a series of 12-bit data bytes. A card is punched after the card image is formed. The controller forms the card image on a column-by-column basis. Normally, the controller performs a BCD (binary coded decimal) to Hollerith conversion. The controller interprets each 12-bit byte as two 6-bit internal BCD codes. It converts each of these codes to a Hollerith code. (Table A-2, Appendix A, lists the two sets of corresponding codes.) Thus, in the first byte, the upper 6 bits are translated into a Hollerith code which is punched in column 1 of the card. The lower 6 bits are also translated into a Hollerith code which is punched in column 2 of the card. The second byte is translated into two Hollerith codes that are punched in columns 3 and 4. Forty 12-bit bytes are required to fill an 80-column card.

The 3446-A/B/C with Standard Option 10194-1 will recognize the data as being ASCII BCD codes only after it has been issued a Set ASCII conversion function code. When this mode is in effect, the controller interprets each 12-bit byte as two 6-bit BCD codes which are routed through a matrix translator. The translator will convert the BCD codes into ASCII Hollerith punch codes. After the data has been converted to ASCII Hollerith, the process of punching cards is the same as when in the standard Hollerith mode; for example, upper 6 bits in column one, lower 6 bits in column 2, etc. See Table A-1 in Appendix A for ASCII Hollerith.

When the Negate BCD to Hollerith mode selected by a function code is in effect, each byte is punched directly in a separate card column. There is no code conversion. Bit 11 of each byte is punched in the top row (row 12) and bit 0 is punched in the bottom row (row 9). Eighty 12-bit bytes are required to fill a card.

The number of data bytes transferred by a single Write instruction may be fewer, the exact number, or more than required to fill one card. When fewer bytes than 40 (BCD) or 80 (binary) are sent to the punch, a card is punched when the data channel terminates the Write operation. If a single Write operation transfers more bytes than can be punched on a card, a second card is punched when the first is filled.

SUPPRESS DISASSEMBLY MODE

The controller automatically enters the Suppress Disassembly mode in response to either of the following 6-bit Output instructions:*

1. Character Addressed Output from Storage (OUTC) in which H (bit 18) = 0.

*3100/3200/3300 systems only

2. Output, Character from A (OTAC).

When this mode is in effect, the controller does not disassemble each 12-bit byte into two BCD codes. Instead, the controller accepts only the lower 6 bits of each byte and converts this code to a corresponding Hollerith code. The above instructions initiate Output operations in which the upper 6 bits of each data byte are all zeros. Thus, no information is lost when the controller discards the upper 6 bits.

CARD CHECK-READ

The card punches have a check-read station located behind the punch station. After a card is punched, it is read and checked for errors while the next card is being punched. As a card image is formed in buffer memory, a count of "1's" is accumulated. This count is stored by the controller. When the card is check-read, a total hole count is prepared and this count is compared with the original count. If the two counts do not agree, an error exists in the card. This condition causes the controller to send an Interrupt signal if the Abnormal End of Operation interrupt is selected. A status line also indicates a comparison error.

LAST CARD CHECK

Normally, a card is check-read only when the next card is punched. When punch operations end, the last card punched does not advance through the check-read station. A function code is available to initiate a check-read cycle for the last card.

SORTING*

A special function code (Select Offset Stacker) offsets a card slightly as it enters the stacker. The code must be issued for each card to be offset within 60 milliseconds after the card is check-read.

PARITY

All information exchanged between the data channel and controller is checked for parity.

* Available on CONTROL DATA 415 Punch only

Parity Error in Connect Code

The controller checks a Connect code sent from the data channel for correct parity. If a parity error is present, the controller does not connect, and Parity Error indicators on all equipments cabled to the data channel light. A Clear Channel instruction or Master Clear should be executed to clear the Parity Error indicators before another operation is executed.

Parity Error in Function Code

The controller checks each function code sent from the data channel for proper parity. If a parity error occurs in a function code, a Parity Error indicator on the controller lights, and the controller sends a Parity Error signal to the data channel. The controller does not execute the function. The Parity Error signal sets the input/output parity error bit in the data channel. This signal should be cleared by a Clear Channel instruction or Master Clear before another operation is initiated.

Parity Error During Write Operation

During Write operations, the controller checks each data byte sent from the data channel for correct parity. If a parity error occurs, the Parity Error indicator on the controller lights, and the controller sends a Parity Error signal to the data channel. This signal sets the input/output parity error bit in the data channel. If the data channel does not terminate the Write operation, the card punch uses the faulty data. The Parity Error signal should be cleared by a Clear Channel instruction or Master Clear.

INTERRUPT

An interrupt feature enables the card punch system to notify the processor when it is ready to begin an operation or when it has completed an operation. Thus, the main program can proceed with minimum regard for card punching operations. Interrupts also allow the punch to notify the central processor when it requires service.

If a specific interrupt has been selected and if the condition(s) specified by it occurs, the controller sends an Interrupt signal to the processor.

If the interrupt system in the processor has been set to recognize the interrupt, the main program is interrupted and control is transferred to a specific program address. If the processor's interrupt system has not been enabled, it is still possible to sense for these conditions via Sense Status and Copy Status instructions written into the main program.

Regardless of which of the above actions is followed, the Interrupt signal remains up until cleared. This clearing may be accomplished by selecting the appropriate interrupt or release (002X), issuing the Release and Disconnect or Clear Function code (0000, 0005) using the Clear Channel instruction or a manual Master Clear. All except reselecting the interrupt will also clear the interrupt selection.

The card punch system transmits the Interrupt signal to the data channel on one of eight interrupt lines. The setting of the eight-position Equipment Number switch on the controller determines which line is used. For example if the switch is set to 4, the Interrupt signal goes out on line 4. Since each equipment attached to the data channel is assigned a unique equipment number, each uses a different interrupt line. A Channel Product Register Jump instruction* or Copy Status instruction** can identify which of several equipments attached to a data channel sends an interrupt by inspecting the eight interrupt lines.

Refer to the appropriate system reference manual for interrupt processing details.

PROGRAMMING

CODES

Table 2 lists all the codes applicable to the 3644-A/B and 3446-A/B/C Controllers. A detailed explanation of each code follows the table.

* 3600/3800 systems

** 3100/3200/3300/3400 systems

TABLE 2. CONNECT, FUNCTION, AND STATUS CODES

Connect	
Connect Punch	N000*
Function	
Release and Disconnect	0000
Negate BCD to Hollerith Conversion	0001
Release Negate BCD to Hollerith Conversion	0002
Select Standard Hollerith**	0002
Select Offset Stacker***	0003
Check Last Card	0004
Clear	0005
Select Interrupt on Ready and Not Busy	0020
Release Interrupt on Ready and Not Busy	0021
Select Interrupt on End of Operation	0022
Release Interrupt on End of Operation	0023
Select Interrupt on Abnormal End of Operation	0024
Release Interrupt on Abnormal End of Operation	0025
Set ASCII Conversion**	0042
Status	
Ready	XXX1
Busy	XXX2
Fail to Feed	X1XX
Interrupt on Ready and Not Busy	X2XX
Interrupt on End of Operation	X4XX
Interrupt on Abnormal End of Operation	1XXX
Compare Error	2XXX
Reserved (by other channel) (3644-A/B only)	4XXX

Connect Code

The card punch system must be connected to a data channel before it responds to a function code or Write operation. A Connect code (N000), the lower 12 bits of the Connect instruction, connects the punch system to the data channel issuing the code. The N portion of the code must match the setting of the eight-position Equipment Number switch. (On the 3644-A/B Controller, there are two Equipment Number switches, one for each channel.) When the controller connects, it returns a Reply signal that permits the central processor to execute the next instruction.

* N = equipment number of controller

** Applicable only to the 3446-A/B/C with Standard Option 10194-1

*** CONTROL DATA 415 Card Punch only.

A Connect code that does not match the Equipment Number switch setting disconnects the controller if previously connected.

The two-channel 3644-A/B Controller contains a channel reservation feature that prevents interference between the two data channels. When the 3644-A/B Controller connects, the reservation is established for the connecting data channel. This reservation remains in effect even if the data channel disconnects the 3644-A/B Controller by connecting another device. A reservation can be cleared only by a Master Clear, Clear Channel instruction, or a Release and Disconnect function code (0000) issued by the data channel having the reservation.

The 3644-A/B Controller generates a Reject signal if a data channel attempts to connect it while reserved by the other data channel. This signal causes the central processor to jump to the reject jump address contained in the Connect instruction.

Even though a Connect operation results in a Reject, the 3644-A/B Controller enables status information to the rejected data channel so that the reason for the reject can be determined.

The 3446-A/B/C is a single-channel controller and thus does not contain a reservation feature.

If for some reason a controller fails to return either a Reply or Reject, the central processor generates an Internal Reject after 100 microseconds. This signal acts the same as a Reject from an external device.

Connect Punch (N000)

This code connects the punch system to a data channel. The N portion of the code must match the setting of the Equipment Number switch.

Function Codes

Function codes set up or release various operating conditions in the punch system.

Table 2 lists all the function codes applicable to the 3446-A/B/C and 3644-A/B Controllers. A function code is the lower 12 bits of a Function instruction. When the central processor executes a Function instruction, the selected data channel sends the function code to all attached devices, but only the connected device responds.

The punch system accepts certain function codes only when it is Not Busy. If one of these codes arrives during a Busy period, the controller returns a Reject signal to the data channel. This signal causes the central processor to jump to the reject jump address contained in the Function instruction.

Any codes not listed in Table 2 are do-nothing codes. The controller returns a Reply in response to such codes, but no action follows.

Release and Disconnect (0000)

This code disconnects the controller and clears the channel reservation. All interrupt selections and Negate BCD to Hollerith selections are cleared. The controller recognizes and replies to this function whether it is Busy or Not Busy.

Negate BCD to Hollerith Conversion (0001)

This code will eliminate any Internal BCD to Hollerith (standard or ASCII) conversion. The data will then be treated as binary and punched directly on a card. Each byte is punched in a separate column. The controller rejects the code when Busy.

Release Negate BCD to Hollerith Conversion (0002)

Select Standard Hollerith (0002)*

This code will return the 3644-A/B and 3446-A/B/C Controllers to the normal internal BCD to standard Hollerith conversion mode. When Standard Option 10194-1 is used in the 3446-A/B/C it is called Select Standard Hollerith and will eliminate the binary mode or BCD to ASCII Hollerith conversion mode. Code 0002 is rejected if the controller is Busy.

Select Offset Stacker (0003)**

This code offsets a card by 3/8 inch in the output stacker of the CONTROL DATA 415 Card Punch. If the selection is to be effective (i. e., offset the card just read), it must be issued within 60 milliseconds after the controller becomes Not Busy. If it is not issued within 60 milliseconds, the card may be only partially offset or not offset at all. A separate function code must be issued for each card to be offset. The function is rejected if the controller is Busy.

* Applicable to the 3446-A/B/C with Standard Option 10194-1

** 415 Card Punch only

Check Last Card (0004)

After the data channel has sent out data for the last card and the card has been punched, the card is positioned at the postpunch read station. The Check Last Card code advances the punch one cycle and performs the total hole count check on the last card. Also, in case of a feed failure, this code should be used to check the last card prior to manual intervention. The controller rejects this code when Busy.

Clear (0005)

A Clear code removes any interrupt selection or interrupt condition and re-establishes the BCD to Hollerith mode of operation. It does not release a reservation or connection. The controller rejects this code when Busy.

Select Interrupt on Ready and Not Busy (0020)

This code conditions the punch system to send an Interrupt signal when it is idle and ready to begin an operation. The controller is Ready when:

1. Cards are present in the input hopper, prepunch, punch, and postpunch stations, and
2. The chip box and stacker are not full

The controller becomes Not Busy after a card is punched only if the data channel has terminated the Output operation. The controller accepts this code whether it is Busy or Not Busy.

Release Interrupt on Ready and Not Busy (0021)

This code inhibits interrupt on Ready and Not Busy. It also clears the Interrupt signal when caused by the Read and Not Busy condition. The controller accepts this code whether Busy or Not Busy.

Select Interrupt on End of Operation (0022)

This code conditions the punch system to send an Interrupt signal at the end of a card punch cycle if one of the following occurs:

1. The data channel terminates the Write operation,
2. The punch system becomes Not Ready, or
3. A comparison error.

The controller rejects this code when Busy.

Release Interrupt on End of Operation (0023)

This code inhibits Interrupt on End of Operation. It also clears the Interrupt signal when caused by an end of operation. The controller rejects this code when Busy.

Select Interrupt on Abnormal End of Operation (0024)

This code conditions the punch system to send an Interrupt signal at the end of a punch cycle if any of the following conditions occur:

1. Feed failure,
2. Stacker full,
3. Input hopper empty,
4. Chip box full, or
5. Comparison error.

Any of the above conditions cause the controller to become Not Ready. Thus, this interrupt may occur concurrently with Interrupt on End of Operation. The controller rejects this code when Busy. The interrupt causing conditions must be corrected before punch operations can resume.

Release Interrupt on Abnormal End of Operation (0025)

This code inhibits Interrupt on End of Operation. It also clears the Interrupt signal when caused by an abnormal condition.

Set ASCII Conversion (0042)**

This code permits the 3446-A/B/C with Standard Option 10194-1 to accept internal BCD codes and convert them into ASCII Hollerith punch codes.* The controller rejects this code if Busy.

Status Codes

Various operating conditions in the punch system are indicated by signals on the twelve status lines. Each line is 1 bit of a standard 12-bit status response. The punch system uses only 8 of these bits. Each status bit is assigned an octal code corresponding to its position in the 12-bit status response. If two or more conditions exist simultaneously, the Status Response code is the sum of the individual codes. This information can be sensed by means of the Copy Status and Sense Status instructions whenever the reader system is connected.

Three of the status lines indicate the three conditions that can cause the controller to send an Interrupt signal. Thus, the status feature can be used to identify the cause of an interrupt.

* Table A-1 (Appendix A) lists the internal BCD codes and corresponding ASCII Hollerith punch codes.

** Applicable only to the 3446-A/B/C with Standard Option 10194-1

Ready (XXX1)—Bit 0

The ready status bit indicates that the punch system can proceed with a Punch operation. The punch is Ready when:

1. Cards are present in the input hopper, prepunch, punch, and postpunch stations,
2. The stacker is not full, and
3. The chip box is not full.

Once Ready, the punch remains Ready until one of the above conditions is not met. If a Not Ready condition arises during a Punch operation, the status bit drops only at the end of the punch cycle.

If the punch STOP switch is pressed, the punch becomes Not Ready at the end of the current punch cycle. The punch becomes Ready again when the RESET or READY switch is pressed.

Busy (XXX2)—Bit 1

The punch system becomes Busy when the data channel initiates a Write operation to load the buffer memory. After the Write operation terminates, the punch remains Busy until the card cycle is complete.

A Check Last Card function code also causes the punch system to become Busy while the hole count check is completed.

Fail to Feed (X1XX)—Bit 6

A feed failure indicates that, when a punch cycle was initiated, a card did not feed from the hopper into the prepunch station.

Interrupt on Ready and Not Busy (X2XX)—Bit 7

This bit indicates that Interrupt on Ready and Not Busy (code 0020) was selected and that this condition now exists.

Interrupt on End of Operation (X4XX)—Bit 8

This bit indicates that Interrupt on End of Operation (code 0022) was selected and that this condition now exists.

Interrupt on Abnormal End of Operation (1XXX)—Bit 9

This bit indicates that Interrupt on Abnormal End of Operation (code 0024) was selected and that this condition now exists.

Compare Error (2XXX)—Bit 10

This bit indicates that the card punched on the previous cycle did not have total hole count equal to the "1" count. The bit remains up until another code is issued to the controller.

Reserved (by other channel) (4XXX)—Bit 11

This bit indicates that the punch is reserved by the other channel (3644-A/B Controller only).

PROGRAMMING CONSIDERATIONS

Programming Procedure

A typical order of steps in programming the punch system is:

1. Clear (external Master Clear or Clear Channel instruction).
2. Connect.
3. Function (select interrupts or Negate BCD to Hollerith mode).
4. Initiate Write operation. Normally, a separate Write operation is initiated for each card.
5. Copy status when interrupt occurs to determine reason for end of operation.
6. Function (check last card after all cards have been punched).
7. Function (Release and Disconnect).

Timing

Table 1, System Specifications, indicates the maximum rates for the two punches. Regardless of the punch being used, fully loading the buffer memory requires 2,200 microseconds for Hollerith punching and 2,560 microseconds for binary punching. To maintain maximum punching rates, the data channel must initiate a new Write operation for the next card shortly after the punch system becomes Not Busy. When the 415 Punch is used, the new Write must be started within 24 milliseconds for full-speed operation.

With the 523 Punch, the new Write must start within 15 milliseconds after the system becomes Not Busy to maintain maximum rate.

When the 415 Punch is used, the punch system becomes Not Busy about 238 milliseconds after the buffer memory is loaded. If the 523 Punch is used, the system becomes Not Busy approximately 598 milliseconds after the memory is loaded.

MANUAL OPERATION

SWITCHES AND INDICATORS

Card Punch Switches and Indicators

Refer to Appendix A for a description of switches and indicators on the CONTROL DATA 415 Punch and the IBM 523 Punch.

Controller Switches and Indicators

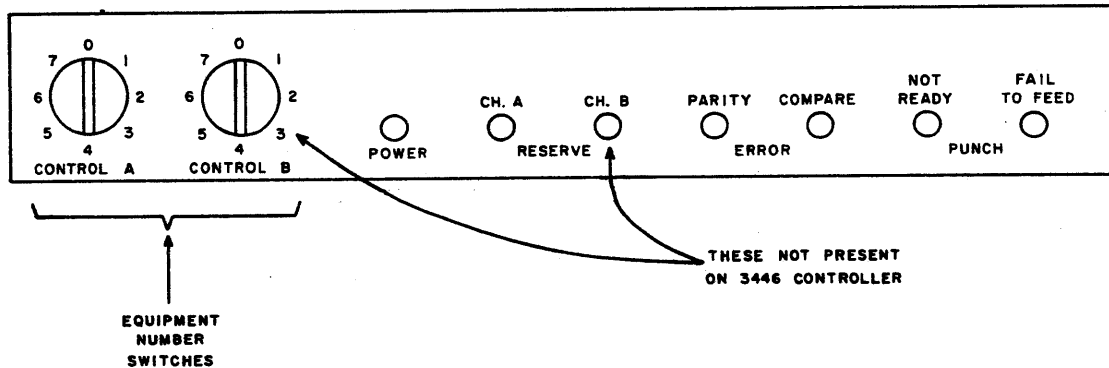

Figure 2. Controller Switches and Indicators

Equipment Number Switches: On the 3446-A/B/C Controller, there is one Equipment Number switch; on the 3644-A/B Controller, there are two, one for each connect-reserve control. This eight-position switch (0-7) determines the equipment number (corresponds to upper 3 bits of Connect code) of a controller. It also determines on which of eight interrupt lines the controller sends an Interrupt signal.

RESERVE Indicators: These indicators (CH. A/CH. B) indicate the channel reserving the punch. They light following a connect and are turned off by a release, a channel clear, or a Master Clear. On the single-channel 3446-A/B/C Controller, there is only one RESERVE indicator.

PARITY ERROR Indicator: This indicator indicates a parity error in the transmission of a Connect or function code from the data channel to the controller. It is turned off by a Clear Channel instruction or a Master Clear.

COMPARE ERROR Indicator: This indicator shows that the controller sensed a difference between the prepunch bit count and postpunch hole count during the comparison check. The indicator is turned off by any function code.

PUNCH NOT READY Indicator: This indicator indicates the punch is not in operable condition due to one of the following conditions:

1. Cards not present in hopper, prepunch, punch, or postpunch stations,
2. Stacker full,
3. Chip box full, or
4. Feed failure.

PUNCH FAIL TO FEED Indicator: This indicator indicates a card failed to feed from the hopper to the prepunch station. It causes a punch Not Ready condition. It is turned off by manually advancing cards from the hopper.

OPERATING PROCEDURE

To prepare the punch for operation:

1. Turn punch On.
 - a. On the 415 Punch, two power switches are located on switch panel.
 - b. On the 523 Punch, the power switch is located on end panel.
2. Place cards face down in hopper with row 9 facing the direction of card feed.
3. Check to see that the chip box and stacker are not full.
4. Advance cards into prepunch and postpunch stations.
 - a. On the 415 Punch, press SINGLE PICK switch twice.

- b. On the 523 Punch, press START switch twice.
- 5. Master Clear from computer.
- 6. The NOT READY and FAIL TO FEED indicators on the controller should not be lighted.
- 7. The punch is now ready for an operation under program control.

SUPPLEMENTARY INFORMATION CARD EQUIPMENT

A

This section contains information common to several of the card handling equipments. This includes:

1. BCD/standard Hollerith and BCD/ASCII Hollerith codes.
2. Card format.
3. CONTROL DATA 405 Card Reader loading procedure.
4. CONTROL DATA 3142 Card Reader card handling and loading information.
5. CONTROL DATA 415 Punch switches and indicators.
6. IBM 523 Punch switches and indicators.

PUNCHED CARD FORMAT AND CODES

A punched card contains either 51 or 80 12-bit columns arranged as in Figure A-1. A punch in any bit position is a logical "1". Cards may be either Hollerith or binary format. In Hollerith format, each column contains a combination of punches that specifies one alphanumeric character. (Table A-1 lists the Hollerith codes.) In binary format, each card column is a 12-bit binary quantity.

TABLE A-1. BCD/ASCII HOLLERITH CARD CODES

Internal BCD Code	ASCII Char	ASCII Hollerith Code	Internal BCD Code	ASCII Char	ASCII Hollerith Code
00	0	0	40	-	11
01	1	1	41	J	11-1
02	2	2	42	K	11-2
03	3	3	43	L	11-3
04	4	4	44	M	11-4
05	5	5	45	N	11-5
06	6	6	46	O	11-6
07	7	7	47	P	11-7
10	8	8	50	Q	11-8
11	9	9	51	R	11-9
12	:	8-2	52	Y	11-0
13	=	8-6	53	\$	11-8-3
14	<	8-7	54	*	11-8-4
15	<	12-8-4	55	@	8-4
16	%	0-8-4	56	?	0-8-7
17	'	8-5	57	>	0-8-6
20	+	12-8-6	60	SPACE	NO PUNCH
21	A	12-1	61	/	0-1
22	B	12-2	62	S	0-2
23	C	12-3	63	T	0-3
24	D	12-4	64	U	0-4
25	E	12-5	65	V	0-5
26	F	12-6	66	W	0-6
27	G	12-7	67	X	0-7
30	H	12-8	70	Y	0-8
31	I	12-9	71	Z	0-9
32	{	12-0	72	!	12-8-7
33	.	12-8-3	73	,	0-8-3
34)	11-8-5	74	(12-8-5
35	\	0-8-2	75	—	0-8-5
36	^	11-8-7	76	#	8-3
37	;	11-8-6	77	&	12

TABLE A-2. BCD/STANDARD HOLLERITH CARD CODES

Internal BCD Code	Char	Hollerith Code	Internal BCD Code	Char	Hollerith Code
00	0	0	40	(minus) -	11
01	1	1	41	J	11, 1
02	2	2	42	K	11, 2
03	3	3	43	L	11, 3
04	4	4	44	M	11, 4
05	5	5	45	N	11, 5
06	6	6	46	O	11, 6
07	7	7	47	P	11, 7
10	8	8	50	Q	11, 8
11	9	9	51	R	11, 9
12		8, 2	52	-0	11, 0
13	=	8, 3	53	\$	11, 8, 3
14	(dash) -	8, 4	54	*	11, 8, 4
15		8, 5	55		11, 8, 5
16		8, 6	56		11, 8, 6
17		8, 7	57		11, 8, 7
20	+	12	60	(Space)	Blank
21	A	12, 1	61	/	0, 1
22	B	12, 2	62	S	0, 2
23	C	12, 3	63	T	0, 3
24	D	12, 4	64	U	0, 4
25	E	12, 5	65	V	0, 5
26	F	12, 6	66	W	0, 6
27	G	12, 7	67	X	0, 7
30	H	12, 8	70	Y	0, 8
31	I	12, 9	71	Z	0, 9
32	+0	12, 0	72		0, 8, 2
33	.	12, 8, 3	73	,	0, 8, 3
34)	12, 8, 4	74	(0, 8, 4
35		12, 8, 5	75		0, 8, 5
36		12, 8, 6	76		0, 8, 6
37		12, 8, 7	77		0, 8, 7

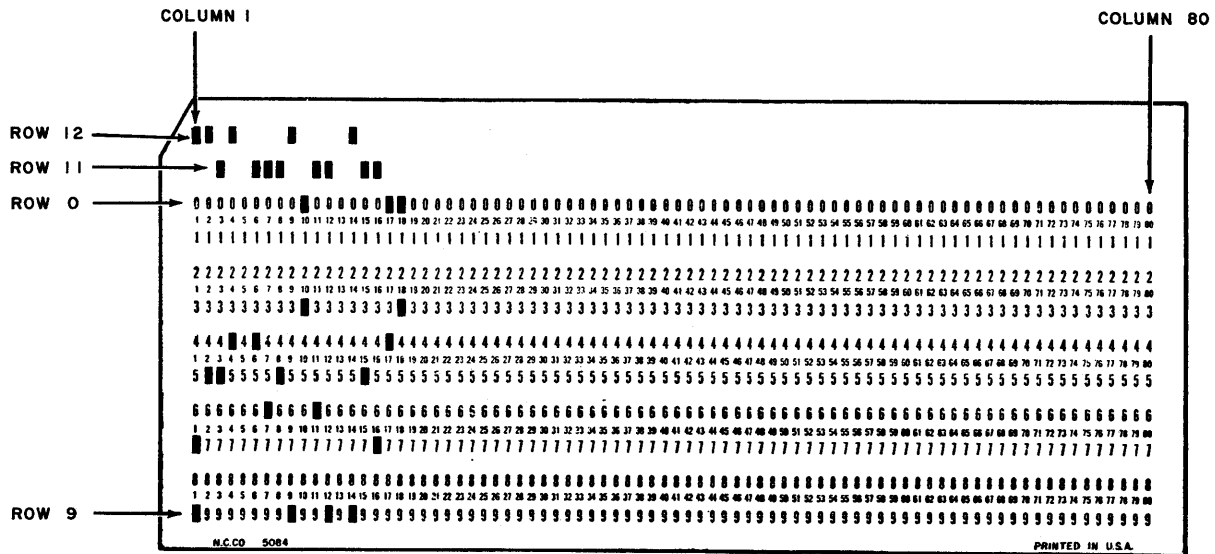

Figure A-1. Punched Card Format

405 CARD READER LOADING PROCEDURES

- 1) Set guide edge of supply tray and receiving tray for length of card being used. Narrow half of each tray may be removed, turned end-for-end and reassembled as necessary.
- 2) Load cards into supply tray, placing column 1 at right as cards face entrance of read station.
- 3) Check input wall of secondary and main receiving trays if 80-column (long) cards are used. Hinged card-stopping blocks should be positioned so that a flush surface is formed at each input wall (Figure A-2). The hinged block assemblies must be pivoted to protrude from the wall surfaces of each receiving tray if 51-column (short) cards are to be used (Figure A-4).
- 4) At input tray, set card-stopping pin to protrude from the face plate if short cards are to be used; turn pin clockwise to form flush wall if long cards are being used (Figures A-2 and A-3).
- 5) Place equipment in manual mode of operation by pressing AUTO/MAN switch (MAN indicator on).

- 6) STOP indicator (controller panel) should be on; if not, press RUN/STOP switch (controller panel).
- 7) Press MOTOR POWER switch (controller panel); indicator should light.
- 8) Press READY switch (controller panel).
- 9) Press SINGLE PICK switch (operator panel) to initiate transport of single card from supply tray to receiving tray. If difficulty is experienced in performing this operation (failure to pick single card), check input throat for possible obstruction.
- 10) Remove card from receiving tray or secondary bin and replace in supply tray.
- 11) Press AUTO/MAN switch to return unit to Auto mode.

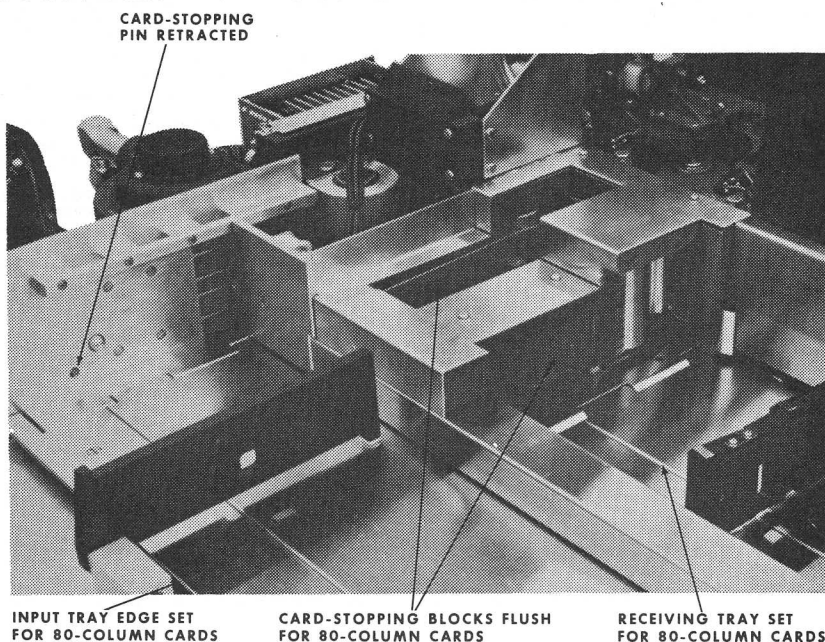

Figure A-2. Card Trays Set for 80-Column Cards

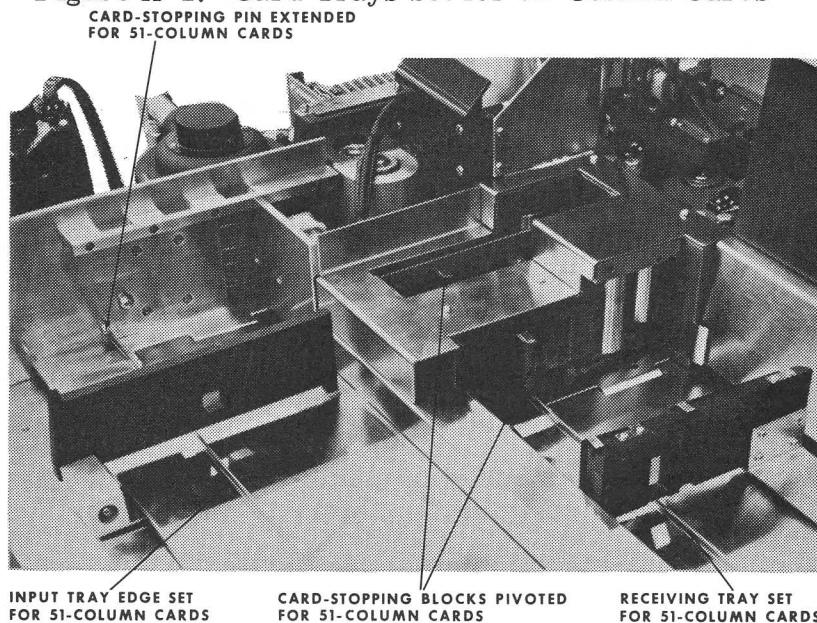

Figure A-3. Card Trays Set for 51-Column Cards

3142 CARD HANDLING AND LOADING INFORMATION

To obtain maximum efficiency from the 3142 Card Reader, care in card handling and loading is necessary. The user who familiarizes himself with the following instructions before operating the 3142 is far less likely to damage the reader or to encounter reading difficulties.

CARD CARE

No extraordinary care is required of card decks to be run through the 3142. However, of course, best machine feeding results from perfectly flat cards. If the cards exhibit slight distortion, the operator can generally eliminate the distortion by gently binding the cards back and forth a few times.

More severe distortion is usually caused by incorrect storage procedures. Cards should be stored so they cannot bind or buckle - either firmly packed into a box or a drawer with an adjustable divider. Occasionally it may be necessary to control storage area humidity in order to prevent permanent warping of cards.

Mechanical damage to cards also causes feeding problems. Any practice which damages the edge, surface, or contour of the card should be avoided. Use of paper clips, staples, rubber bands, etc., mars the card and may cause machine feeding difficulties.

NATIONAL CASH REGISTER EM-D2 (PE) PUNCHED CARD READER

Use Figure A-4 to locate the parts of the 3142 card reader that are referred to on the following pages.

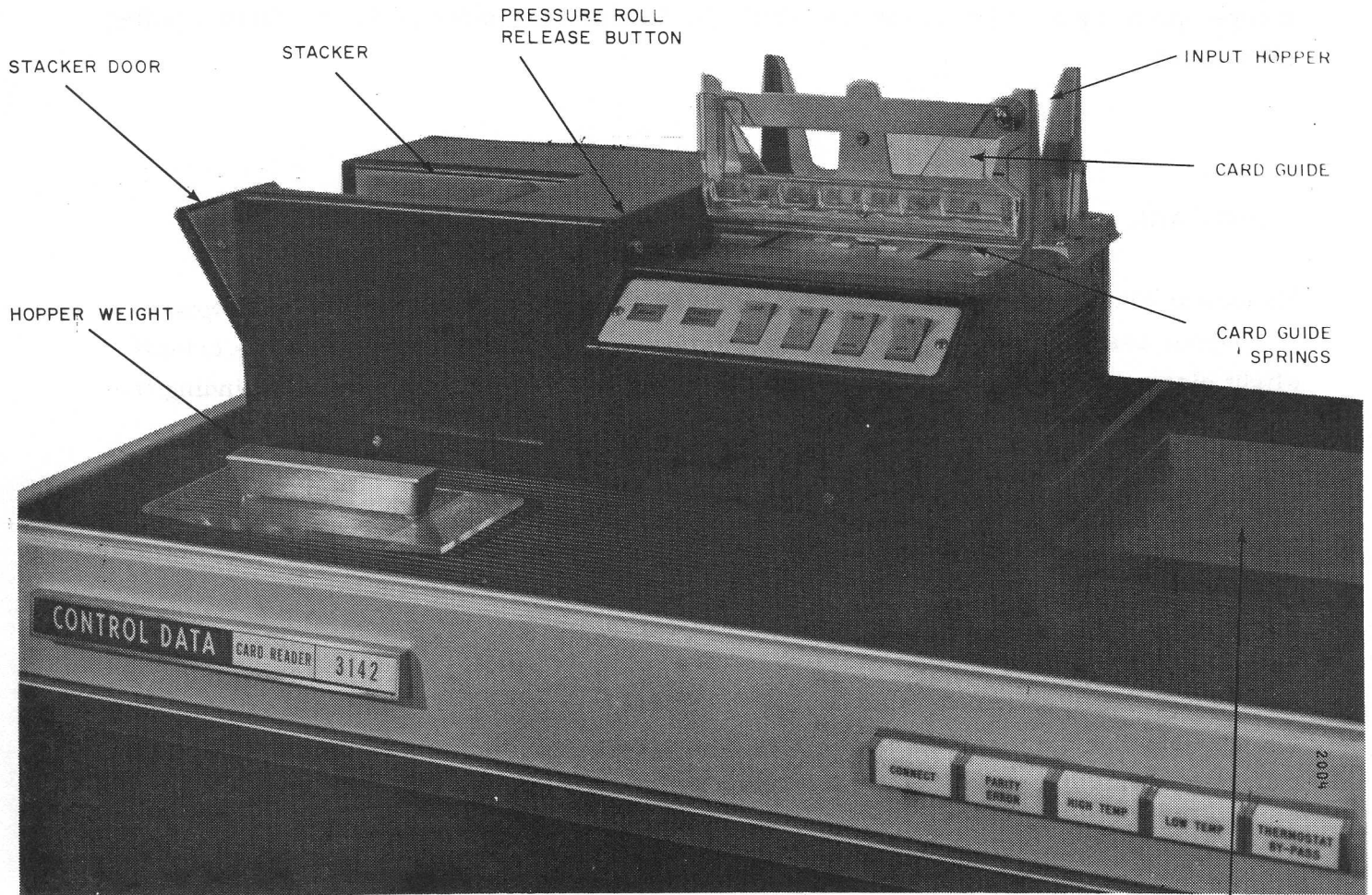

Figure A-4. 3142 Card Reader

JOGGLE PLATE

Reader Loading

- 1) Align the cards on the joggle plate by gentle tapping. If the card edges do not align easily, do not damage the edges by banging the deck against the plate. Instead, lightly fan the deck and try again.
- 2) Using both hands as shown in Figure A-5, transfer the squared deck to the reader hopper without destroying the alignment. The proper card position is face down with the nine edge (bottom) toward the rear of the reader.

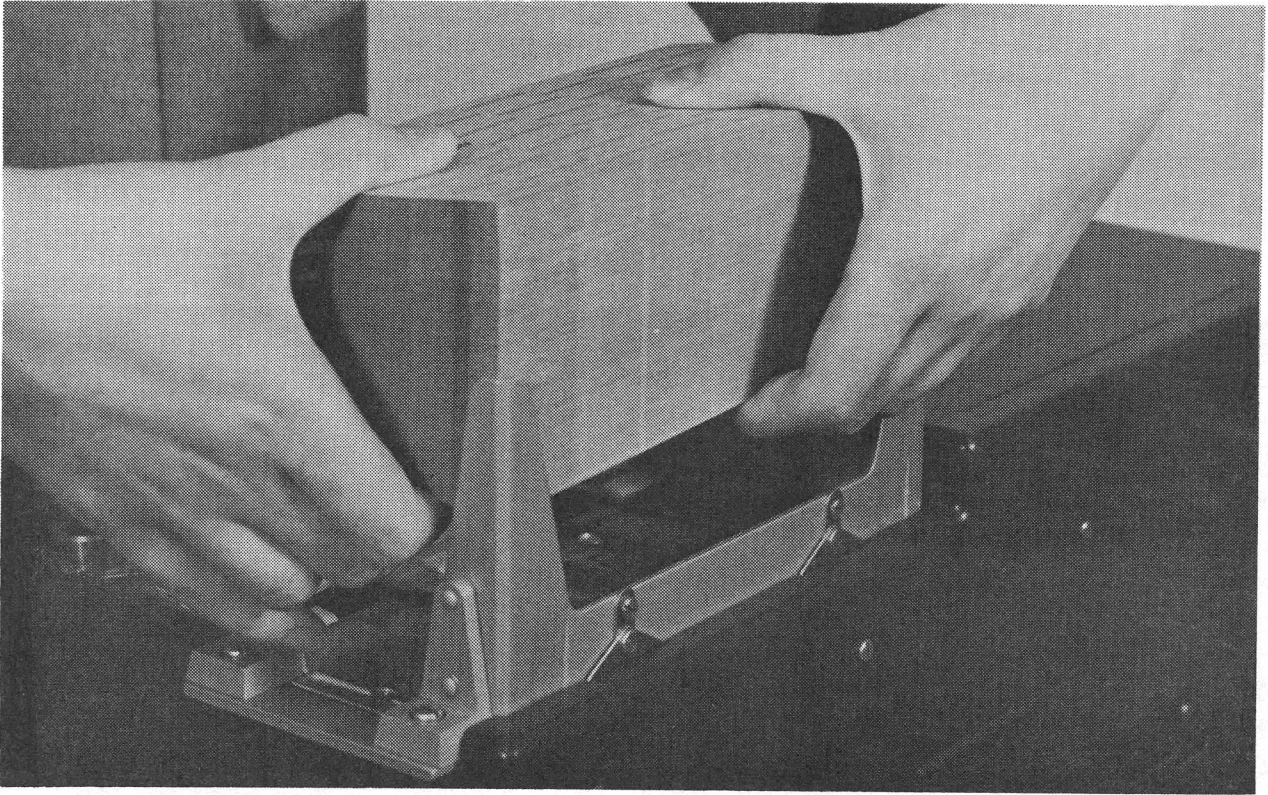

Figure A-5. Transferring Aligned Deck to Reader Hopper

- 3) Replace the hopper weight.
- 4) Check that the plastic card guide on the reader table is down.
- 5) Depress the REG key once.

Jam Removal

To remove a card caught in the hopper throat area:

- 1) Protect fingers by turning reader power off or depressing the MAN switch. Either operation prevents feed knife motion.
- 2) Pull the card gently toward the front of the machine. This prevents bending the card guide springs.

CAUTION

Some models of the reader have four fragile card guide springs in the hopper throat area. These are shown in Figure A-4. Care must be exercised to prevent damage to these springs.

To remove a card caught in the read station actuate the pressure roll release button as shown in Figure A-6.

PRESSURE ROLL RELEASE BUTTON

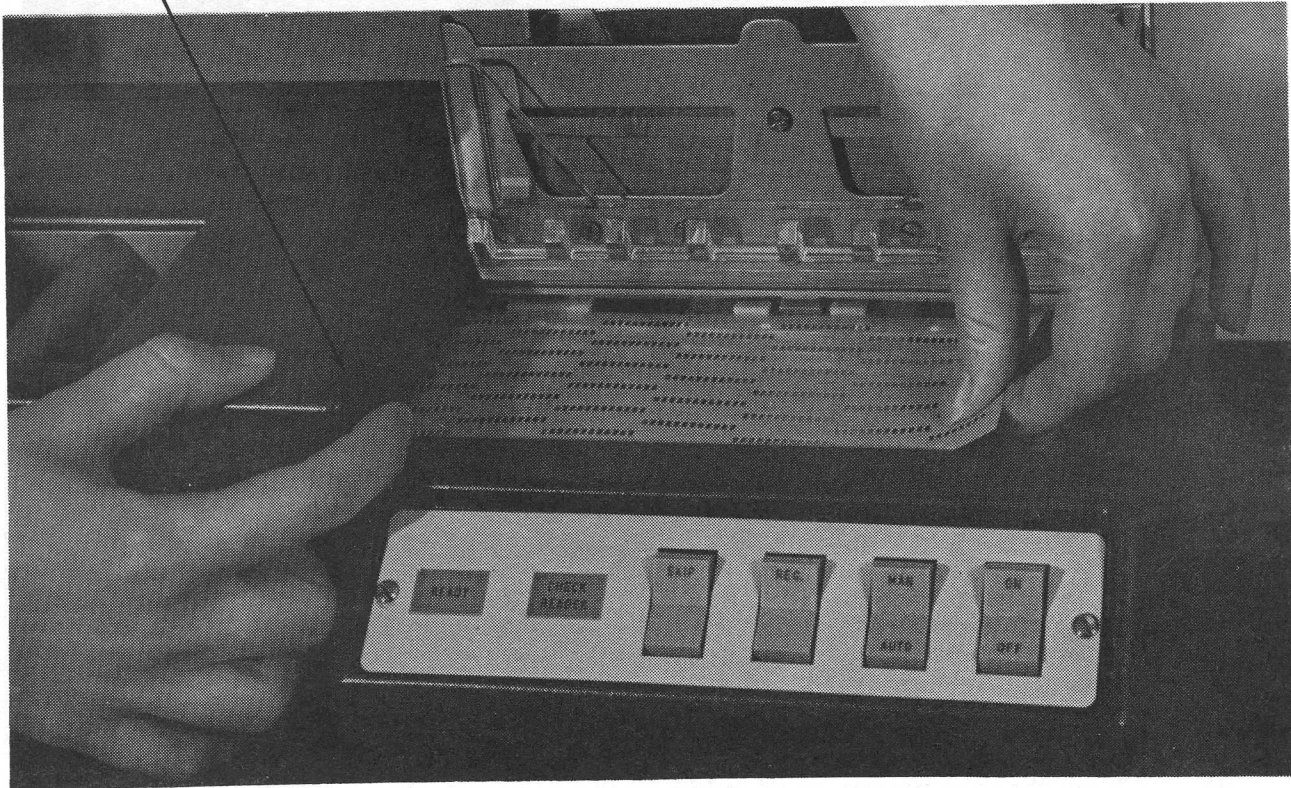

2003

Figure A-6. Removal of Card from Read Station

Reader Unloading

- 1) Open the stacker door at the left end of the card reader, and
- 2) Pull the deck out through the door.

415 CARD PUNCH SWITCHES AND INDICATORS

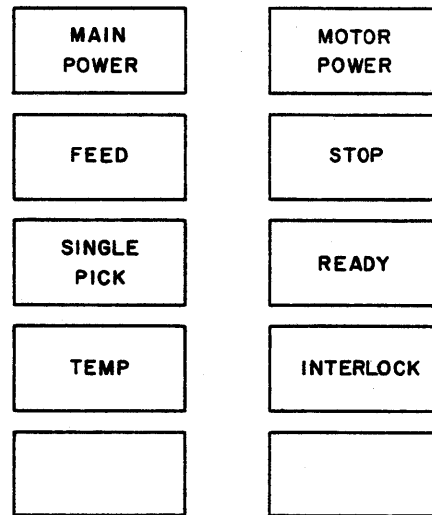

Figure A-7. 415 Punch Switches and Indicators

MAIN POWER SWITCH

This switch applies power to the cooling fans and the power supplies. It is lighted when power is on.

MOTOR POWER SWITCH

This switch applies power to the punch motor. It is lighted when power is on.

FEED INDICATOR

This indicator is lighted when a card jam exists.

STOP SWITCH

This switch causes the punch to become Not Ready. It is lighted when the punch is in a Not Ready condition.

SINGLE PICK SWITCH

This switch advances cards one cycle. It is lighted until the advance has been completed.

READY SWITCH

This switch clears punch logic and puts the punch in Automatic mode. It is lighted when punch is in Ready condition.

TEMPERATURE INDICATOR

This indicator is lighted whenever the card punch temperature exceeds 100° F.

INTERLOCK INDICATOR

This indicator is lighted when the head panel, hood panel, or right door is open.

523 CARD PUNCH SWITCHES AND INDICATORS

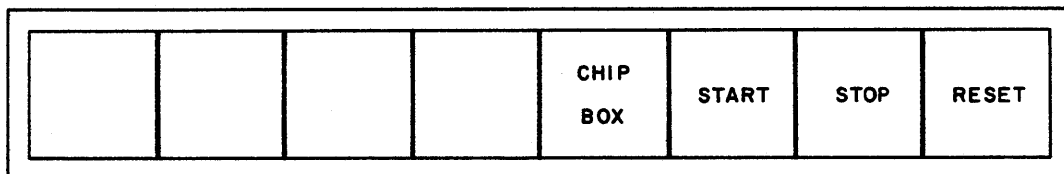

Figure A-8. 523 Punch Switches and Indicators

OFF/ON SWITCH

This switch applies power to the punch. It is located on the end panel on the right.

START SWITCH

This momentary-contact switch causes the cards to advance one cycle. From an initial load, pressing this switch twice advances cards into all stations. At the end of the operation, pressing switch twice unloads punched cards.

STOP SWITCH

This switch causes the punch to become Not Ready.

RESET SWITCH

This switch causes the punch to become Ready following a reload or unload. It does not advance the cards.

CHIP BOX INDICATOR

This indicator is lighted whenever the chip box is full.

COMMENT SHEET

MANUAL TITLE CDC 3446-A/B/C, 3644-A/B Standard Option 10194-1
Card Punch Controllers Reference Manual

PUBLICATION NO. 60332100 REVISION B

FROM: NAME: _____
BUSINESS
ADDRESS: _____

CUT ALONG LINE

PRINTED IN U.S.A.

AA3419 REV. 7/75

NO POSTAGE STAMP NECESSARY IF MAILED IN U. S. A.
FOLD ON DOTTED LINES AND STAPLE

STAPLE

STAPLE

FOLD

FOLD

FIRST CLASS
PERMIT NO. 8241
MINNEAPOLIS, MINN.

BUSINESS REPLY MAIL
NO POSTAGE STAMP NECESSARY IF MAILED IN U.S.A.

POSTAGE WILL BE PAID BY
CONTROL DATA CORPORATION
Publications and Graphics Division
ARH219
4201 North Lexington Avenue
Saint Paul, Minnesota 55112

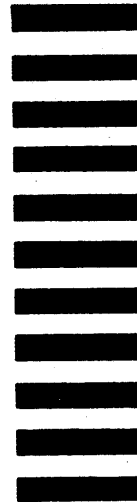

CUT ALONG LINE

FOLD

FOLD